

High-Frequency GR900[®] Precision Coaxial Components

The GR900[®] line of precision coaxial components consists of:

50-Ohm Connectors

Basic, cable, and panel connectors and connector kits

50-Ohm Adaptors

Adaptors to most popular connector types

50-Ohm Terminations and Attenuators

Short-circuit, open-circuit, and resistive terminations

Tuners

Fixed attenuators

50-Ohm Air Lines

Fixed air lines

75-Ohm Components NEW

Connectors, adaptors, and terminations

Miscellaneous

Ells, tools, cleaning kit, tube and rod



GR900® Precision Coaxial Components

The first precision series For many years it was difficult to improve the design of highly accurate high-frequency measuring equipment since any improvements were obscured by connector difficulties. This fact spurred General Radio, with its long experience in coaxial-connector development, to design the first commercial coaxial connector that could honestly be called "precision" — the GR900® connector.

A versatile choice The successful development of the GR900® connector signaled the initiation of an entire line of precision coaxial components and instruments. These, together with connector kits and precision rod and tubing, can bring GR900 precision to every corner of your laboratory.

Electrical characteristics One of the most important characteristics of a connector is standing-wave ratio and in the GR 900-BT connector $SWR < (1.001 + 0.001 f_{GHz})$. Of ever greater importance in many applications is connector repeatability because this sets the limit of measurement accuracy. The GR 900-BT connector offers repeatability of ± 0.002 dB in insertion loss, $\pm 0.008^\circ$ in insertion phase, and 0.05% in SWR.

Leakage of the GR900 connector is better than 130 dB below signal level — lower than that of any other commonly used coaxial connector. This remarkable characteristic is due to the triple shielding action of the butt contact between outer conductors, the interlocking and overlapping of the centering gear rings, the threaded engagement of the outer locking nut, and the precise machining of the mating surfaces. Insertion loss is extremely small, due to the unique design of the contacts and the use of very low-loss materials — Teflon* for the bead and solid-silver alloys for both inner and outer conductors.

Electrical length of a connector pair is 3.50 cm and is virtually independent of frequency. Dc resistance is typi-

cally $0.4 \text{ m}\Omega$ for the inner conductors and $0.04 \text{ m}\Omega$ for the outer conductors of a mated pair.

The 900-BT connector meets all specifications contained in Part III, Section 1 of the IEEE Standard for Precision Coaxial Connectors, No. 287. The connectors are available in pairs, each with a calibration certificate that verifies the combined SWR of the pair to be within the limits specified in the IEEE document.

Mechanical characteristics The spring contact and inner conductor are made of gold-plated solid-silver alloy; the bead support, Teflon; the centering gear ring, stainless steel; the outer conductor, gold-plated coin silver; the retaining ring, phosphor bronze; and the coupling and locking nuts, chrome-plated brass.

When the parts are assembled onto an air line, the coupling nut and retaining ring attach the outer conductor of the connector to the outer conductor of the line. The inner conductor is threaded into the center conductor of the air line and is supported by the Teflon bead.

When two connectors are mated, the centering gear rings interlock and overlap to center the connectors with respect to each other. The interlocking also prevents the connectors from rotating against each other (with possible impairment of repeatability and reliability). The front surfaces of the outer conductors meet at a common reference plane, where they butt firmly together under the pressure of the locking nut.

The front surface of the inner conductor is recessed 0.001 inch with respect to the reference plane of the outer conductor, to ensure outer-conductor contact. Inner-conductor contact is made by a springy center contact assembly that projects slightly beyond the reference plane of the outer conductor until the connector is mated. The spring contact assembly consists of six independently sprung segments that are forced back and together upon mating, thereby making a wiping contact with both the inside of the inner conductor and the mating face of the other center contact. This connector structure is free from the reflections that would be caused by slots in the inner and outer conductors. It will give you exceptionally long life, with excellent repeatability, in part because micro-abrasion of the rubbing surfaces cannot affect the electrically critical conductor diameters.

* Registered trademark of the E. I. du Pont de Nemours and Company.

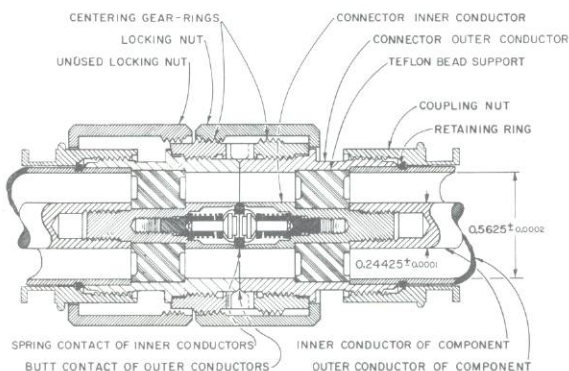

Cross-section view of mated 900-BT Precision Coaxial Connectors.

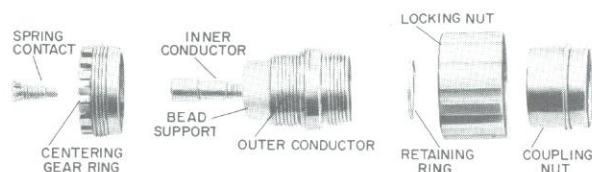

Exploded view of 900-BT Precision Coaxial Connector.

GR900® 50-Ohm Connectors

Basic Precision Connector

For use on rigid, 14-mm, air-dielectric 50-Ω coaxial lines (principal dimensions of 0.5625 in. and 0.24425 in.). The basic connectors are available as single connectors or as a pair of connectors with calibration certificate; the same SWR specification applies to either. These limits are those approved in the IEEE Recommended Practice for Precision Coaxial Connectors in the 14-mm general precision connector class. 900-BT Connectors are 100% tested at six frequencies. The 900-TOK Tool Kit is recommended for proper assembly.

Frequency: Dc to 8.5 GHz.

SWR: $\leq (1.001 + 0.001 f_{GHz})$ applies to single connectors and pairs.

Repeatability: SWR: Within 0.05%. INSERTION LOSS: ± 0.001 dB to 30 MHz, ± 0.002 dB to 1 GHz, ± 0.0025 dB to 8.5 GHz. PHASE: Within 0.008° at 1 GHz, 0.015° at 2 GHz, 0.05° at 6 GHz.

Electrical: IMPEDANCE: $50 \Omega \pm 0.1\%$ at frequencies where skin depth is negligible. INPUT VOLTAGE: Up to 3000 V pk. POWER average into 50-Ω load: Up to 20 kW, dc to 1 MHz, decreasing as $1/\sqrt{f}$ at higher f. INSERTION LOSS: $< (0.003 \sqrt{f_{GHz}})$ dB per pair. LEAKAGE: > 130 dB below signal. ELECTRICAL LENGTH: 3.500 ± 0.005 cm per pair; 1.750 ± 0.0025

cm for single connector. DC CONTACT RESISTANCE: < 0.07 mΩ for outer conductor, < 0.5 mΩ for inner conductor.

Mechanical: DIMENSIONS: 1.19 in. (30 mm) long x 1.06 in. (27 mm) dia. WEIGHT: 0.2 lb (0.1 kg) net.

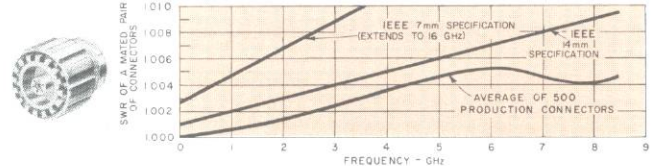

Typical and specified SWR of single and certified pairs of 900-BT Precision Coaxial Connectors. Specified SWR is identical to that given as IEEE Recommended Practice.

Description	Catalog Number
50-Ω Basic Precision Coaxial Connectors	
900-BT, single	9900-9405
900-BT, pair, with calibration certificate	9900-9407

Low-Cost Basic Precision Connector

For use on rigid, 14-mm, air-dielectric 50-Ω coaxial lines (principal dimension of 0.5625 in. and 0.24425 in.). The GR890 is a low-cost version of the GR900® precision coaxial connector and is intended for use when the lowest SWR is not required. Below 500 MHz, the difference in SWR, compared with the GR900, is insignificant; above 500 MHz, the SWR specification is somewhat degraded. For example, at 8 GHz the SWR specification is 1.019, compared with 1.009 for the GR900.

The GR 890 connector is generally used at lower frequencies on capacitance, inductance, or resistance standards, and at higher (microwave) frequencies where the SWR of the device is much greater than that of the connector. The other useful properties of the GR900 series, such as repeatability, well-defined reference plane, and low contact resistance, are retained. Grooves in the 890-BT locking nut distinguish the low-cost version from the 900-BT connector, but they mate without restriction.

Frequency: Dc to 8.5 GHz.

SWR: $< (1.003 + 0.002 f_{GHz})$ per connector. For mated connectors, add SWR specs, i.e., double this spec for pair of 890 connectors.

Repeatability: SWR: $\leq \pm 0.0005$ or $\pm 0.05\%$. INSERTION LOSS: ± 0.001 dB to 30 MHz, ± 0.002 dB to 1 GHz, ± 0.0025 dB to 8.5 GHz. PHASE: $\leq 0.008^\circ$ at 1 GHz, 0.015° at 2 GHz, 0.05° at 6 GHz.

Electrical: IMPEDANCE: $50 \Omega \pm 0.3\%$ at frequencies where skin depth is insignificant. INPUT VOLTAGE: Up to 3000 V pk. POWER, average into 50-Ω load: Up to 20 kW, dc to 1 MHz, decreasing as $1/\sqrt{f}$ at higher f. INSERTION LOSS: $< (0.004 \sqrt{f_{GHz}})$ dB per pair. LEAKAGE: > 130 dB below signal. ELECTRICAL LENGTH: $(3.500 + 0.005 - 0.01)$ cm per pair; $(1.750 + 0.0025 - 0.005)$ cm for single connector. DC CONTACT RESISTANCE: < 0.07 mΩ for outer conductor, < 0.5 mΩ for inner conductor.

Mechanical: DIMENSIONS: 1.19 in. (30 mm) long x 1.06 in. (27 mm) dia. WEIGHT: 0.2 lb (0.1 kg) net.



50-Ω Low-Cost Basic Precision Coaxial Connector	
890-BT, single	0890-9405

Basic Precision Connector Kits

For custom fabrication of rigid, 14-mm, air-dielectric 50-Ω coaxial lines and terminations compatible with the GR900® connector. Rigid air lines can be made from GR900 Precision Rod (0900-9507) and Tube (0900-9509) to serve as precision capacitance or time-delay standards, as well defined reactance standards, and as dielectric sample holders for dielectric-constant and loss measurements with the slotted line. The connectors formed by these three kits are beadless.

900-AP for unsupported inner conductor The 900-AP is for use on elements that have unsupported inner conductors. A reference air line can be assembled from a pair of these kits and appropriate lengths of precision rod and tube. The kit consists of locking nut, centering gear ring, and a spring-loaded centering pin that allows the inner conductor of the resulting beadless air line to derive its support from the mating 900-BT Connector.

900-AC for supported inner conductor The 900-AC can be used in place of the 900-BT on any component whose inner conductor is supported within the component itself. The kit consists of locking nut, centering gear ring, and center contact of a standard GR900 connector. Since it includes only those parts necessary for its particular application, this kit

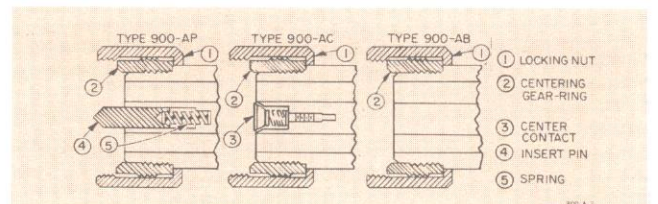

◆ Federal stock numbers are listed before the Index.

offers superior electrical performance at a considerable savings in cost.

900-AB for supported inner conductor, less center contact. The 900-AB can be used to fabricate an air line to be mated with a 900-BT Connector, but it cannot mate with a 900-LZ Reference Air Line or with another 900-AB or 900-AP Connector. The 900-AB is like the -AC in appearance and function, except it does not contain the center contact. Repeatability is specified in %; example: if SWR varies from 1.00012 to 1.00016 (for a pair mated successively), the repeatability is ± 0.00002 or $\pm 0.002\%$.

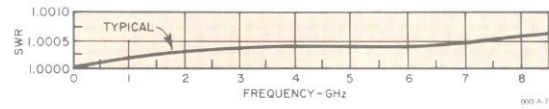

Description

Catalog Number

50- Ω Laboratory Precision Connector Kits

- 900-AP, repeatability within $\pm(0.010 + 0.003 f_{GHz})\%$
- 900-AC, repeatability within $\pm 0.05\%$
- 900-AB, repeatability within $\pm(0.010 + 0.003 f_{GHz})\%$

- 0900-9406
- 0900-9404
- 0900-9402

Cable Precision Connectors

For use with more than 20 different RG types of coaxial cable. The SWR of these connectors is much lower than that of even the best-made cables. The braid retention system does not compress the cable, yet it has good pull and torque

resistance. The usual distortion and flow of cable dielectric during inner-conductor soldering have been virtually eliminated by means of a Teflon spacer and a special, low-temperature solder supplied with every connector. All inner-conductor parts are captive and supported by a bead.

SWR of connector itself is represented by "ideal section" data (see curves) measured with precision coaxial line in place of cable.

Frequency: Dc to 8.5 GHz.

Electrical: IMPEDANCE: 50 Ω . INPUT VOLTAGE: Up to 1500 V pk for -C9; 500 V pk for -C58. INSERTION LOSS: $<(0.006 f_{GHz})$ dB per pair for -C9; $<(0.010 \sqrt{f_{GHz}})$ dB per pair for -C58.

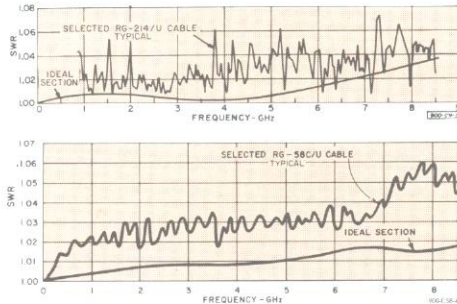

Typical SWR performance of a single Type 900-C9 Connector on an "infinite" length of RG-214/U cable and on an "ideal" section with the same diameters.

50- Ω Coaxial Cable Precision Connectors

For RG-9B/U and RG-214/U cable; can be used, with some sacrifice in performance or mechanical reliability, with RG-8/U, -8A/U, -10A/U, -87A/U, -116/U, -156/U, -165/U, -166/U, -213/U, -215/U, -225/U, and -222/U:

900-C9

0900-9421

For GR 874-A3 and RG-58/U cable; has limited application with RG-29/U, -55/U, -141A/U, -142A/U, -159/U, and -233/U:

900-C58

0900-9431

Panel Mounting Kits

Used to mount standard GR 890 and GR900 connectors on a panel. Kit includes a threaded flange that accepts the outer conductor, mounting hardware, and a gear ring that, for the rotatable version, can be turned to permit any desired angular orientation of the mating connector.

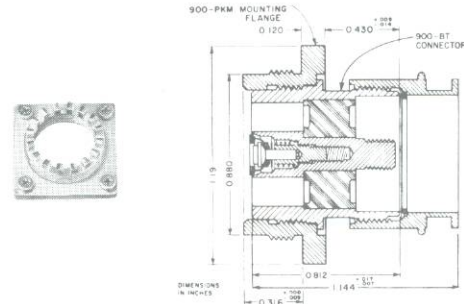

Description

Catalog Number

Panel Mounting Kits

- 900-PKM, non-rotatable
- 900-PKMR, rotatable

- 0900-9498
- 0900-9500

Rotatable Centering Ring

Permits proper mating with another GR 890 or GR900 connector in any orientation. Threads onto the connector in place of the regular centering gear ring.

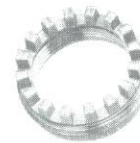

Rotatable Centering Ring

0900-9499

Adaptor Flange

To connect GR900 components to instruments (like some bridges) that terminate in a broad plane surface and to a variety of flange-type connectors. This flange threads onto a 900-BT Connector in place of the centering gear ring and locking nut.



Adaptor Flange

0900-9782

GR900® 50-Ohm Adaptors

Conversion plus precision The availability of precision adaptors from the GR900® connectors to other popular coaxial connectors means that the user of GR900 equipped instruments can convert to other series and still retain precision performance. For example, a 900-LB Precision Slotted Line equipped with a 900-QNJ or -QNP adaptor becomes a

type N slotted line with an over-all residual SWR (line plus adaptor) of only 1.02 at 3 GHz. Conversely, users of instruments equipped with SMA, TNC, N, C, and GR874® connectors can, by means of adaptors, take advantage of the precision offered by GR900 tuners, airline standards, terminations, and other elements.

50-Ohm Precision Adaptor Kit

This set consists of the most commonly used GR900 precision adaptors including one each of the jack and plug versions of adaptors to BNC, C, N, SC, SMA, and TNC, as well as adaptors to Amphenol APC-7, Precifix AA, and GR874® connectors. All components are supplied in an attractive mahogany storage case with recessed foam inserts.

Mechanical: WEIGHT: 8 lb (3.7 kg) net, 12 lb (5.5 kg) shipping.

Description	Catalog Number
GR900 Precision Adaptor Set	0900-9451
GR900 Storage Case	0900-9450

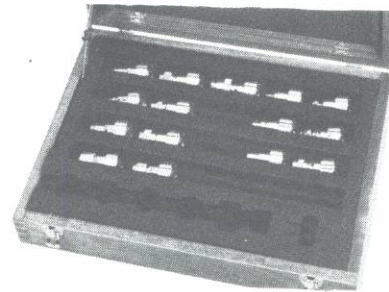

Precision Adaptors to BNC

Two versions: One includes a BNC jack and the other includes a BNC plug. Both use a GR900 precision connector on the other end.

Frequency: Dc to 8.5 GHz.

SWR: $<(1.005 + 0.015 f_{GHz})$ to 1 GHz, $<(1.015 + 0.005 f_{GHz})$ to 8.5 GHz.

Electrical: IMPEDANCE: 50 Ω nominal. INPUT VOLTAGE: Up to 500 V pk. POWER, average into 50- Ω load: Up to 3 kW, dc to 1 MHz, decreasing as $1/\sqrt{f}$ at higher f.

Mechanical: WEIGHT: 0.3 lb (0.2 kg) net; 1.3 lb (0.6 kg) shipping.

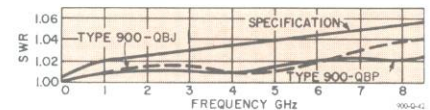

Description	Catalog Number
50- Ω Precision Adaptors to BNC 900-QBJ, with BNC jack	0900-9701
900-QBP, with BNC plug	0900-9801

Precision Adaptors to C

Two versions: One includes a type C jack and the other includes a type C plug. Both use a GR900 precision connector on the other end.

Frequency: Dc to 8.5 GHz.

SWR: $<(1.005 + 0.015 f_{GHz})$ to 1 GHz, $<(0.015 + 0.005 f_{GHz})$ to 8.5 GHz.

Electrical: IMPEDANCE: 50 Ω nominal. INPUT VOLTAGE: Up to 1000 V pk. POWER, average into 50- Ω load: Up to 7 kW, dc to 1 MHz, decreasing as $1/\sqrt{f}$ at higher f.

Mechanical: WEIGHT: 0.3 lb (0.2 kg) net; 1.3 lb (0.6 kg) shipping.

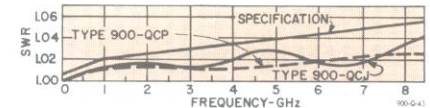

Description	Catalog Number
50- Ω Precision Adaptors to C 900-QCJ, with C jack	0900-9703
900-QCP, with C plug	0900-9803

Precision Adaptors to N

Two versions: One includes a type N jack and the other includes a type N plug. Both use a GR900 precision connector on the other end.

Frequency: Dc to 8.5 GHz.

SWR: $<(1.004 + 0.004 f_{GHz})$ to 8.5 GHz.

Electrical: IMPEDANCE: 50 Ω nominal. INPUT VOLTAGE: Up to 1000 V pk. POWER, average into 50- Ω load: Up to 7 kW, dc to 1 MHz, decreasing as $1/\sqrt{f}$ at higher f.

Mechanical: WEIGHT: 0.3 lb (0.2 kg) net; 1.3 lb (0.6 kg) shipping.

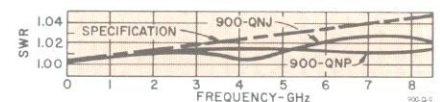

Description	Catalog Number
50- Ω Precision Adaptors to N 900-QNJ, with N jack	0900-9711
900-QNP, with N plug	0900-9811

◆ Federal stock numbers are listed before the Index.

Precision Adaptors to TNC

Two versions: One includes a TNC jack and the other includes a TNC plug. Both use a GR900 precision connector on the other end.

Frequency: Dc to 8.5 GHz.

SWR: $<(1.005 + 0.015 f_{GHz})$ to 1 GHz, $<(1.015 + 0.005 f_{GHz})$ to 8.5 GHz.

Electrical: IMPEDANCE: 50 Ω nominal. INPUT VOLTAGE: Up to 500 V pk. POWER, average into 50- Ω load: Up to 3 kW, dc to 1 MHz, decreasing as $1/\sqrt{f}$ at higher f.

Mechanical: WEIGHT: 0.3 lb (0.2 kg) net; 1.3 lb (0.6 kg) shipping.



Description

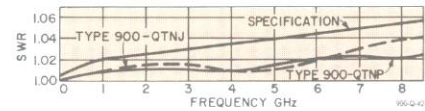

50- Ω Precision Adaptors to TNC
900-QTNJ, with TNC jack
900-QTNP, with TNC plug

Catalog
Number

0900-9717
0900-9817

Precision Adaptors to SMA

Two versions: One includes an SMA jack and the other includes an SMA plug. Both use a GR900 precision connector on the other end.

Frequency: Dc to 8.5 GHz.

SWR: $<(1.005 + 0.025 f_{GHz})$ to 1 GHz, $<(1.022 + 0.008 f_{GHz})$ to 8.5 GHz.

Electrical: IMPEDANCE: 50 Ω nominal.

Mechanical: WEIGHT: 0.3 lb (0.2 kg) net; 1.3 lb (0.6 kg) ship.

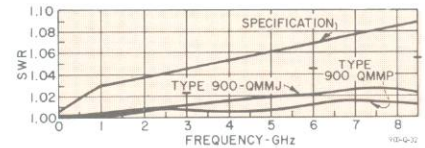
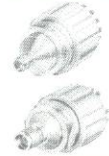

50- Ω Precision Adaptors to SMA
900-QMMJ, with SMA jack
900-QMMP, with SMA plug

0900-9723
0900-9823

Precision Adaptors to SC

Two versions: One includes an SC jack and the other includes an SC plug. Both use a GR900 precision connector on the other end.

Frequency: Dc to 8.5 GHz.

SWR: $<(1.005 + 0.015 f_{GHz})$ to 1 GHz, $<(1.015 + 0.005 f_{GHz})$ to 8.5 GHz.

Electrical: IMPEDANCE: 50 Ω nominal. INPUT VOLTAGE: Up to 1000 V pk. POWER, average into 50- Ω load: Up to 7 kW, dc to 1 MHz, decreasing as $1/\sqrt{f}$ at higher f.

Mechanical: WEIGHT: 0.3 lb (0.2 kg) net; 1.3 lb (0.6 kg) ship.

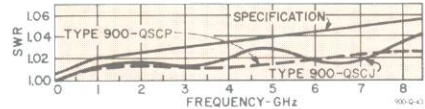

50- Ω Precision Adaptors to SC
900-QSJP, with SC jack
900-QSJP, with SC plug

0900-9713
0900-9813

Precision Adaptors to 7-mm Precision

Includes an Amphenol APC-7 or R&S 7-mm connector on one end and a GR900 precision connector on the other.

Frequency: Dc to 8.5 GHz.

SWR: $<(1.003 + 0.003 f_{GHz})$ to 8.5 GHz.

Electrical: IMPEDANCE: 50 Ω nominal. INPUT VOLTAGE: Up to 1000 V pk. POWER, average into 50- Ω load: Up to 6 kW, dc to 1 MHz, decreasing as $1/\sqrt{f}$ at higher f. ELECTRICAL LENGTH: 5.30 ± 0.02 cm.

Mechanical: WEIGHT: 0.3 lb (0.2 kg) net; 1.3 lb (0.6 kg) ship.

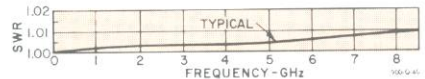

50- Ω Precision Adaptor to 7-mm Precision
900-QAP7, with APC-7 connector
900-QPF7, with R&S 7-mm connector

0900-9791
0900-9793

Precision Adaptor to GR874® Connector

Includes a locking GR874 connector on one end and a GR900 precision connector on the other end.

Frequency: Dc to 8.5 GHz.

SWR: $<(1.00 + 0.015 f_{GHz})$ to 1 GHz, $<(1.010 + 0.005 f_{GHz})$ to 8.5 GHz.

Electrical: IMPEDANCE: 50 Ω nominal. INPUT VOLTAGE: Up to 1500 V pk. POWER, average into 50- Ω load: Up to 10 kW, dc to 1 MHz, decreasing as $1/\sqrt{f}$ at higher f.

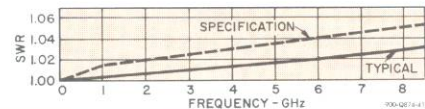

50- Ω Precision Adaptor to GR874
900-Q874, with locking GR874 connector

0900-9883

Precision Adaptor to Binding Posts

One convertible version: Adapts binding posts (spaced on 0.75- to 1-in. centers) to GR900 connector and (after a simple mechanical modification) adapts GR900 connector to binding posts. Particularly useful for converting "unknown" terminals of bridges.

Electrical: RESIDUAL IMPEDANCE: When binding posts are adapted to GR900, ≈ 3.55 pF and ≈ 4.8 nH are added to terminals. When GR900 is adapted to binding posts, ≈ 5.2 pF

and ≈ 11 nH are added at base and ≈ 20 nH at top of binding posts.

Mechanical: WEIGHT: 0.3 lb (0.2 kg) net; 1.3 lb (0.6 kg) ship.



50- Ω Precision Adaptor to Binding Posts
900-Q9

0900-9874

◆ Federal stock numbers are listed before the Index.

GR900® 50-Ohm Precision Terminations and Attenuators

Precision Resistive Terminations and Mismatches

Standard terminations are useful for calibration of bridges, slotted lines, admittance bridges, network analyzers, and reflectometers. The 50-ohm 900-W50 termination can also be used as a precision dummy load or as a termination in measurements of networks with more than one port. This termination, together with the 900-WNC Short Circuit and 900-LZ Air Lines, can form a calibration set for computer correction of measuring instruments. With an appropriate GR900 adaptor, it can be used as a low-SWR, precision type-N termination, or BNC, or C, etc.

Standard mismatches introduce reflections of known SWR in a 50-ohm transmission line and are therefore useful in the calibration of reflectometers, network analyzers, and SWR-measuring instruments.

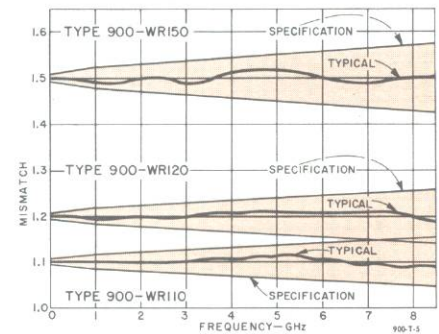
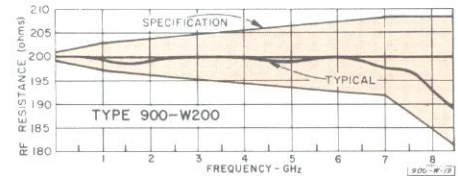
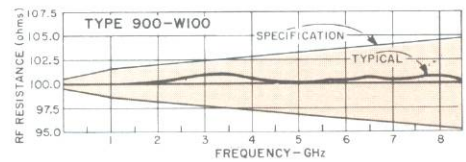
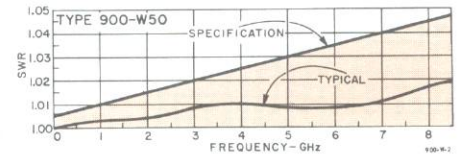

Frequency: Dc to 8.5 GHz.

900	-W50	-W100	-W200	-W110	-W120	-W150
Dc Resistance:	50 Ω	100 Ω	200 Ω	45.45 Ω	41.67 Ω	33.33 Ω
Accuracy:	±0.3%	±0.5%	±0.5%	±0.5%	±0.5%	±0.5%
SWR, also see curves:	1.005 ± 0.005 f _{GHz}	—	—	1.1 nom	1.2 nom	1.5 nom
Plane Position*:	—	4 cm nom	4 cm nom	—	—	—

Electrical: INPUT POWER: <1 W with negligible change, <5 W without damage. TEMPERATURE COEFFICIENT: <150 ppm/°C.

Mechanical: DIMENSIONS: 2 in. (51 mm) long x 1.06 in. (27 mm) dia. WEIGHT: 0.2 lb (0.1 kg) net.

Description	Catalog Number
Precision Resistive Terminations	
900-W50 50-Ω Standard Termination	0900-9953
900-W100 100-Ω Standard Termination	0900-9957
900-W200 200-Ω Standard Termination	0900-9959
Precision Mismatches:	
900-WR110 Standard Mismatch, SWR 1.1	0900-9961
900-WR120 Standard Mismatch, SWR 1.2	0900-9963
900-WR150 Standard Mismatch, SWR 1.5	0900-9965

Open-Circuit Terminations

Open-circuit terminations are useful in establishing initial conditions of line length and signal phase, as shielding caps for open-circuited lines, and, at low frequencies, as capacitance standards.

Frequency: Dc to 8.5 GHz.

Plane Position*: For 900-WO, typically 0.26 cm, but varies with frequency within ± 0.012 cm of value shown on graph. For -WO4, 4.00 ± 0.01 cm (corresponds to 4-cm offset in 900-W100 and -W200 Standard Terminations).

Electrical: CAPACITANCE: 0.172 ± 0.008 pF for -WO, at low frequencies; 2.670 pF ± 0.25% for -WO4, below 70 MHz.



900-WO4

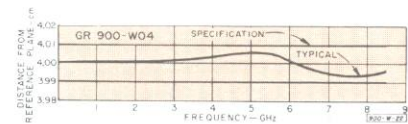

900-WO

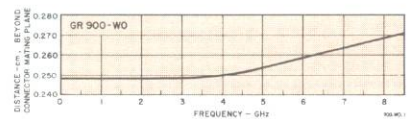

Precision Open-Circuit Terminations	Catalog Number
900-WO, plane at 2.6 mm	0900-9981
900-WO4, plane at 4 cm	0900-9985

* Location of effective position of termination, measured toward "load", from reference plane of connector (where outer conductors butt together).

Precision Short-Circuit Terminations

Short-circuit terminations are useful in establishing initial conditions of line length and signal phase in, for example, impedance measurements. An s-c termination consists of a precision-machined, silver-plated disk, mounted in a centering gear ring and locking-nut assembly, to produce a fixed short circuit. The 900-WNC, -WNE, and -WN4 each includes a support for one end of the inner conductor of a 900-LZ Reference Air Line, which is beadless.

Frequency: Dc to 8.5 GHz.

Plane Position:* For 900-WN and -WNC, 0.00 cm; for 900-WNE, 0.26 ± 0.005 cm (corresponding open circuit is 900-WO); for 900-WN4, 4.00 ± 0.01 cm (corresponding resistive terminations are 900-W100 and -W200).

Reflection Coefficients: >0.999 for -WN and -WNC, >0.998 for -WNE, >0.996 for -WN4; all to 8.5 GHz.

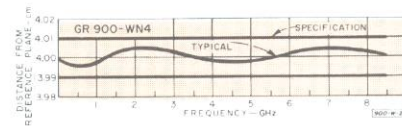
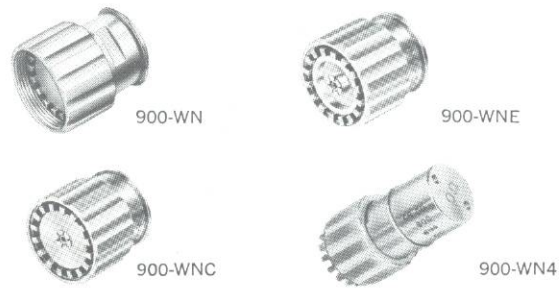

Description

Catalog Number

50-Ω Precision Short-Circuit Terminations

900-WN, without support, plane at 0.00 cm
900-WNC, with support, plane at 0.00 cm
900-WNE, with support, plane at 2.6 mm
900-WN4, with support, plane at 4 cm

0900-9971
0900-9977
0900-9979
0900-9975

Precision Tuner

Used to match out small residual reflections in low-SWR measuring instruments and devices. The tuner has three smoothly adjustable tuning screws that are used in pairs to tune out reflections of any phase throughout the tuner's frequency range. Each screw has a "neutral" setting, independent of frequency, at which it is effectively out of the circuit. Screws can be locked at any setting to enhance the excellent SWR resetability and to protect against accidental disturbance. They can be partially clamped for the desired friction.

Frequency: 1 to 8.5 GHz.

SWR Matching Range: 1.00 to $1.00 + 0.012 f_{\text{GHz}}$, worst-case minimum. RESETTABILITY: $<(1.0005 + 0.0003 f_{\text{GHz}})$.

Repeatability: 0.05% (limited by connector).

Electrical: IMPEDANCE: 50 Ω nominal. INSERTION LOSS: <0.1 dB to 4 GHz, <0.3 dB to 8.5 GHz. ELECTRICAL LENGTH: 12.0 cm.

Mechanical: DIMENSIONS: 4.5x3.5x1 in. (114x89x25mm). WEIGHT: 1 lb (0.5 kg) net, 3 lb (1.4 kg) shipping.

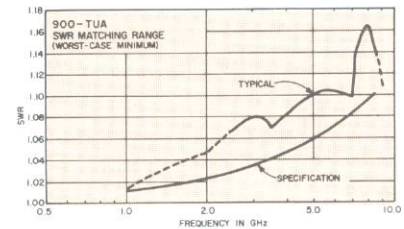
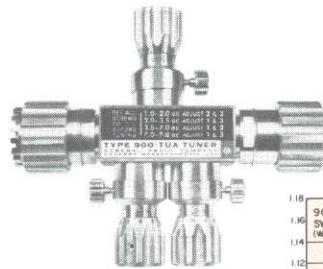

900-TUA Tuner

0900-9635

Precision Fixed Attenuators

GR900 attenuators permit greatly improved accuracy in the measurement of insertion loss, impedance, power, or phase, which requires precise impedance matching of the source and detector. In particular, they are ideal for swept measurements of these quantities. In point-by-point measurements, they reduce or eliminate the need to tune out residual reflections from source or detector.

The SWR characteristic of these attenuators is much lower than was previously available, and they exhibit uniform attenuation over a wide frequency range. They display a high degree of repeatability in SWR, contact resistance, and insertion loss, factors that contribute to their value in substitution measurements. The high repeatability and low SWR also permit them to be accurately calibrated for use as attenuation standards.

Frequency: Dc to 8.5 GHz.

Attenuation Accuracy: ± 0.04 dB at dc, ± 0.2 dB to 5 GHz, ± 0.3 dB to 8.5 GHz. TEMPERATURE COEFFICIENT: <0.0001 dB/°C/dB.

SWR: $<(1.005 + 0.005 f_{\text{GHz}})$.

Electrical: IMPEDANCE: 50.0 Ω. INPUT POWER: <1 W continuous, or <500 W peak with <1 W average. DC RESISTANCE: $50.0 \Omega \pm 0.3\%$ when terminated in 50.0 Ω.
Mechanical: DIMENSIONS: 3.75 in. (95 mm) long. WEIGHT: 0.7 lb (0.4 kg) net.

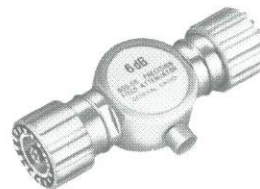

Description

Catalog Number

50-Ω Precision Fixed Attenuators:
900-G6, 6 dB
900-G10, 10 dB

0900-9850
0900-9851

◆ Federal stock numbers are listed before the Index.

* Location of effective position of termination, measured toward "load", from reference plane of connector (where outer conductors butt together).

GR900® 50-Ohm Precision Air Lines

Reference-Air-Line Set

This set consists of one each of the seven lengths of 900-LZ Reference Air Lines, a 900-WN4 short circuit, and a 900-WO4 open circuit. All components are supplied in an attractive mahogany storage case, with recessed foam insets, which also can be supplied separately.

Mechanical: WEIGHT: 8 lb (3.7 kg) net, 13 lb (6 kg) shipping.

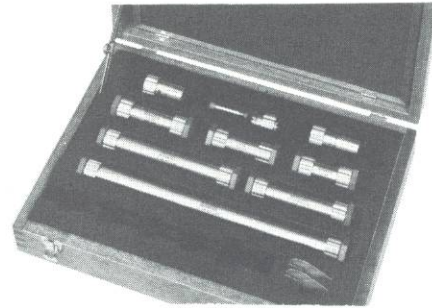

Description	Catalog Number
GR900 Reference-Air-Line Set	0900-9452
GR900 Storage Case	0900-9450

Reference Air Lines

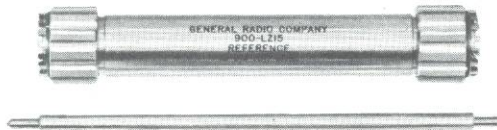

For use in calibrations, especially in substitution measurements, as precision capacitance or time-delay standards, as well defined reactance standards, as dielectric sample holders for dielectric-constant and loss measurements with slotted lines and network analyzers, and as absolute impedance references in time-domain reflectometry. The 900-LZ series are beadless, virtually reflectionless coaxial air lines, with spring-loaded supporting tips on the ends of the inner conductor to mate with GR900 connectors; microfinished outer-conductor ends make butt contact with the mating connectors.

Frequency: Dc to 8.5 GHz.

SWR: $<(1.0005 + 0.0002 f_{\text{GHz}})$; calibration data supplied.

Repeatability: SWR: Within $(0.010 + 0.003 f_{\text{GHz}})\%$.

Electrical: IMPEDANCE: $50 \Omega \pm 0.05\%$ at 23°C and where skin depth is negligible. Additional skin-effect error is calculable.¹ INPUT VOLTAGE: Up to 3000 V pk. POWER, average into 50- Ω load: Up to 20 kW, dc to 1 MHz, decreasing as

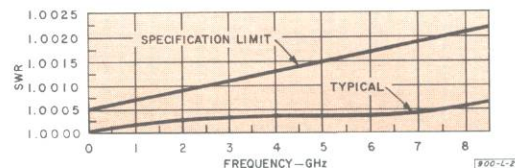

$1/\sqrt{f}$ at higher f . INSERTION LOSS: $<(0.0008 \sqrt{f_{\text{GHz}}})$ dB/cm. LEAKAGE: >130 dB below signal. DC CONTACT RESISTANCE each end, when mated with GR900 connector: <0.07 m Ω for outer conductor, <0.5 m Ω for inner conductor.

50- Ω Reference Air Lines

Type	Electrical Length (± 0.002 cm) cm	Capacitance ($\pm 0.07\%$) pF	Time Delay (± 0.1 ps) ps	Odd $\lambda/4$ Frequencies* GHz	Catalog Number
900-LZ3	2.998	2.0000	100.0	$(2n+1) 2.50$	0900-9603
900-LZ5	4.997	3.3333	166.7	$(2n+1) 1.50$	0900-9600
900-LZ6	5.996	4.0000	200.0	$(2n+1) 1.25$	0900-9601
900-LZ7H	7.495	5.0000	250.0	$(2n+1) 1.00$	0900-9602
900-LZ10	9.993	6.6667	333.3	$(2n+1) 0.75$	0900-9604
900-LZ15	14.990	10.0000	500.0	$(2n+1) 0.50$	0900-9606
900-LZ30	29.979	20.0000	1000.0	$(2n+1) 0.25$	0900-9612

* Frequencies at which air-line section is an odd multiple of a quarter wavelength, where n is zero or any integer).

Precision Air Lines



Useful as low-SWR line extenders, as 50-ohm impedance standards at frequencies at which the electrical length is an odd multiple of a quarter wavelength, as capacitance and time-delay standards, and as absolute impedance standards in time-domain reflectometry. Each line consists of a short section of precision 50-ohm air line with a GR900 connector at each end.

Frequency: Dc to 8.5 GHz.

SWR: $<(1.0013 + 0.0013 f_{\text{GHz}})$.

Electrical: IMPEDANCE: $50 \Omega \pm 0.065\%$. Additional skin-effect error is calculable.¹ INPUT VOLTAGE: Up to 3000 V pk. POWER, average into 50- Ω load: Up to 20 kW, dc to 1 MHz, decreasing as $1/\sqrt{f}$ at higher f . DC CONTACT RE-

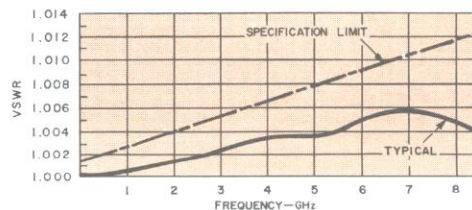

STANCE each end, when mated with GR900 connector: <0.07 m Ω for outer conductor, <0.5 m Ω for inner conductor.

50- Ω Precision Air Lines

Type	Electrical Length (± 0.02 cm) cm	Capacitance pF	Time Delay (± 1 ps) ps	Insertion Loss dB	Catalog Number
900-L3	3	2.0000	100	$<0.005 \sqrt{f_{\text{GHz}}}$	0900-9608
900-L10	10	6.6667	333	$<0.012 \sqrt{f_{\text{GHz}}}$	0900-9605
900-L15	15	10.000	500	$<0.016 \sqrt{f_{\text{GHz}}}$	0900-9607
900-L30	30	20.000	1000	$<0.028 \sqrt{f_{\text{GHz}}}$	0900-9613

¹ J. Zorzy, "Skin-Effect Corrections in Standards," *IEEE Transactions on Instrumentation and Measurement*, Vol. IM-15 No. 4, December 1966, p. 358 (GR Reprint A-134).

GR900® 75-Ohm Components

**New Since
Catalog U**

New versatility. A new series of GR900® general-purpose coaxial components extends the versatility of the line to the field of 75-ohm transmission-line measurements. The series includes matching pads and adaptors to permit direct conversion of existing 50-ohm systems to the 75-ohm capability.

The GR900 75-ohm components use a connector similar to the 50-ohm counterpart except for an identifying black coupling nut and modified inner conductor and insulating bead. Performance for the new components is specified up to 1 GHz but they are useful to 8.5 GHz or higher.

Basic Precision Connector

For use on rigid, 14-mm, air-dielectric, 75-Ω coaxial lines or with capacitance, inductance, and resistance standards.

Frequency: Dc to 1 GHz, usable to 9 GHz.

SWR: $< (1.0015 + 0.0015 f_{GHz})$.

Repeatability: SWR: ± 0.0006 ($\pm 0.06\%$). INSERTION LOSS: ± 0.001 dB to 30 MHz, ± 0.002 dB to 1 GHz. PHASE: 0.01° at 1 GHz.

Electrical: IMPEDANCE: $75 \Omega \pm 0.3\%$. INPUT VOLTAGE: Up to 3000 V pk. POWER, average into matched load: Up to 18 kW, dc to 1 MHz, decreasing as $1/\sqrt{f}$ at higher f. INSERTION LOSS: $< 0.004 \sqrt{f_{GHz}}$ per pair. LEAKAGE: > 130 dB below signal. ELECTRICAL LENGTH: Nom 1.75 cm (3.5 cm, mated pair); exactly 1.7488 \pm 0.0038 cm (3.4976 \pm 0.0076 cm). DC CONTACT RESISTANCE: < 0.07 mΩ for outer conductor, < 0.5 mΩ for inner conductor.

Mechanical: DIMENSIONS: 1.19 in. (30 mm) long x 1.06 in. (27 mm) dia. WEIGHT: 0.2 lb (0.1 kg) net, 1 lb (0.5 kg) shipping.



Description

900-BT (75-Ω) Precision Coaxial Connector

Catalog
Number

0900-9730

Precision Adaptors to Type F

Two adaptors are available; one includes a type F jack and the other includes a type F plug. Each uses a GR900 (75-Ω) connector on the other end. Type F jacks are designed for use with 0.023-in. dia (0.58 mm) wire.

Frequency: Dc to 1 GHz.

Electrical: IMPEDANCE: 75 Ω nominal.

Mechanical: DIMENSIONS: 0900-9738 1.92 in. (49 mm) long; 0900-9739 1.75 in. (44 mm) long; either, 1.06 in. (27 mm) dia. WEIGHT: 0.2 lb (0.1 kg) net, 1 lb (0.5 kg) shipping.



Description

Catalog
Number

75-Ω Adaptors to F

900-QFJ (75-Ω), with type F jack

900-QFP (75-Ω), with type F plug

0900-9738

0900-9739

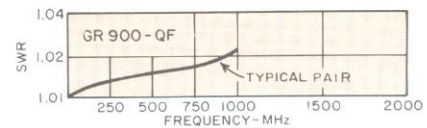

900175111 1

Precision Adaptors to Large WE

Two adaptors are available; one includes a large Western Electric jack and the other includes a large Western Electric plug. Each uses a GR900 (75 Ω) locking connector on the other end.

Frequency: Dc to 1 GHz.

Electrical: IMPEDANCE: 75 Ω nominal.

Mechanical: DIMENSIONS: 0900-9736 3.4 in. (86 mm) long; 0900-9737 2.9 in. (74 mm) long; either, 1.06 in. (27 mm) dia. WEIGHT: 0.2 lb (0.1 kg) net, 1 lb (0.5 kg) shipping.

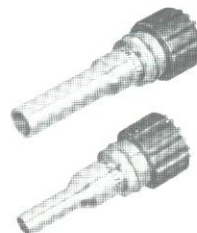

75-Ω Adaptors to Western Electric, large

900-QWJL (75-Ω), with large WE jack

900-QWPL (75-Ω), with large WE plug

0900-9736

0900-9737

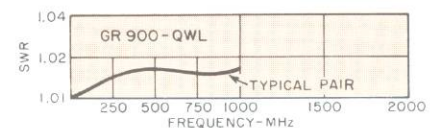

900175112 2

Precision Adaptors to Small WE

Two adaptors are available; one includes a small Western Electric jack and the other includes a small Western Electric plug. Each uses a GR900 (75- Ω) locking connector on the other end.

Frequency: Dc to 1 GHz.

Electrical: IMPEDANCE: 75 Ω nominal.

Mechanical: DIMENSIONS: 0900-9734 2.89 in. (73 mm) long; 0900-9735 2.62 in. (67 mm) long; either, 1.06 in. (27 mm) dia. WEIGHT: 0.2 lb (0.1 kg) net, 1 lb (0.5 kg) shipping.

Description	Catalog Number
75-Ω Adaptors to Western Electric, small	
900-QWJS (75- Ω), with small WE jack	0900-9734
900-QWPS (75- Ω), with small WE plug	0900-9735

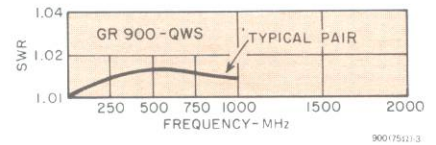
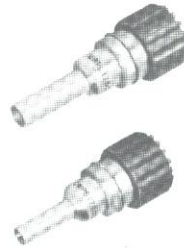

Precision Adaptor, 75- to 50-Ohm GR900

Includes a GR900 (50- Ω) connector on one end and a GR900 (75- Ω) connector on the other end. It is a mechanical adaptor for the conversion from GR900 50-ohm connectors to GR900 75-ohm connectors (it is not an impedance transformer; see 900-MP below).

Frequency: Dc to 1 GHz, usable to 8.5 GHz.

Electrical: IMPEDANCE: 50 $\Omega \pm 0.3\%$ for 50- Ω side; 75 $\Omega \pm 0.5\%$ for 75- Ω side. LEAKAGE: > 130 dB below signal. ELECTRICAL LENGTH: 4 ± 0.01 cm for 50- Ω side; 0.24 ± 0.005 cm for 75- Ω side.

Mechanical: DIMENSIONS: 1.66 in. (42 mm) long x 1.06 in. (26 mm) dia. WEIGHT: 0.2 lb (0.1 kg) net, 1 lb (0.5 kg) shipping.



Description	Catalog Number
900-Q75 Precision Adaptor, 50 to 75- Ω	0900-9731

75- to 50-Ohm Precision Matching Pad

A two-port minimum-loss network to match 50-ohm GR900-equipped devices to similarly equipped 75-ohm devices. It features low SWR, low leakage, and the excellent repeatability inherent in GR900 connectors.

Frequency: Dc to 1 GHz, usable to 8.5 GHz.

SWR: Better than 1.003 + 0.003 f_{GHz} for 50- Ω side, 1.01 + 0.012 f_{GHz} for 75- Ω side.

Electrical: IMPEDANCE: 50 Ω and 75 Ω . INPUT: 1 W max continuous. INSERTION LOSS: 5.72 dB nominal. LEAKAGE: > 130 dB below signal.

Mechanical: DIMENSIONS: 3.75 in. (95 mm) long x 1.06 in. (27 mm) dia. WEIGHT: 0.6 lb (0.3 kg) net, 2 lb (1 kg) shipping.

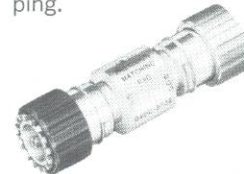

900-MP 50 to 75- Ω Precision Matching Pad	0900-9732
--	-----------

Precision 75-Ohm Termination

A fixed 75- Ω resistor mounted in a GR900 (75 Ω) connector for establishing reference conditions in coaxial lines, for impedance matching, for use as a termination, for the calibration of bridges, slotted lines, and reflectometers, and for use as a dummy load in network measurements.

Frequency: Dc to 1 GHz, usable to 9 GHz.

SWR: < (1.005 $\pm 0.005 f_{GHz}$).

Electrical: IMPEDANCE: 75 $\Omega \pm 0.3\%$, temperature coefficient < 150 ppm/ $^{\circ}C$. INPUT: 1 W with negligible change, 5 W without damage.

Mechanical: DIMENSIONS: 1.83 in. (47 mm) long x 1.06 in. (27 mm) dia. WEIGHT: 0.2 lb (0.1 kg) net, 1 lb (0.5 kg) shipping.



900-W75 (75- Ω) Precision Standard Termination	0900-9733
--	-----------

GR900® Miscellaneous

50-Ohm Precision 90° EII

Permits coaxial devices, such as vertical liquid-dielectric sample holders, to be physically oriented as required, with better electrical performance than could be obtained with flexible cable.

Frequency: Dc to 8.5 GHz.

SWR: $<(1.004 + 0.004 f_{GHz})$.

Electrical: IMPEDANCE: $50 \Omega \pm 0.4\%$ at frequencies where skin depth is small. INPUT VOLTAGE: Up to 1500 V pk. POWER, average into 50- Ω load: Up to 10 kW, dc to 1 MHz, decreasing as $1/\sqrt{f}$ at higher f. INSERTION LOSS: $(0.017 \sqrt{f_{GHz}})$ dB. ELECTRICAL LENGTH: $[10.00 + 0.0014 (f_{GHz})^2 \pm 0.02]$ cm.

Mechanical: Gear rings rotatable, for proper mating in any orientation. MATING DIMENSIONS: 2.066 in. (5.246 mm) from center line of one connector to reference plane of other connector. OVER-ALL DIMENSIONS: 2.69x2.69x0.88 in. (68x68x22 mm). WEIGHT: 0.7 lb (0.3 kg) net.

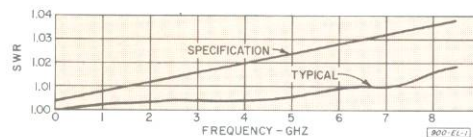

Description

900-EL Precision 90° EII

Catalog Number

0900-9527

Tool Kit

Nine-piece tool kit in fitted case for convenient installation of 890-BT, 900-BT, 900-C58, and 900-C9 50-ohm precision coaxial connectors. With 0900-9904 accessory tools, the kit can also be used for 900-BT (75 Ω) connectors. Complete instructions are included.

Mechanical: WEIGHT: 7 lb (3.2 kg) shipping.

Description

900-TOK Tool Kit

Accessory Tools, for use with 900-TOK on 900-BT (75 Ω) connectors

Catalog Number

0900-9902

0900-9904

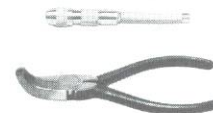

Storage Case and Cleaning Kit

Storage Case

An attractive mahogany case with firm, foamed plastic inserts having molded recesses designed to hold various types of GR900® precision coaxial components. An excellent way to keep together a set of adaptors, air lines, terminations, and the like and to carry or store them with minimum exposure to dirt or damage to the precision machined surfaces.

Mechanical: WEIGHT: 8 lb (3.7 kg) shipping.

Cleaning Kit

For cleaning both 50-ohm and 75-ohm GR900 connectors. Solvent supplied in 16-oz aerosol will not affect insulator nor any metal surface in these connectors. Kit also includes two brushes and 24 lint-free wiping pads.

GR900 Storage Case

900-TOC Cleaning Kit

0900-9450

0900-9610

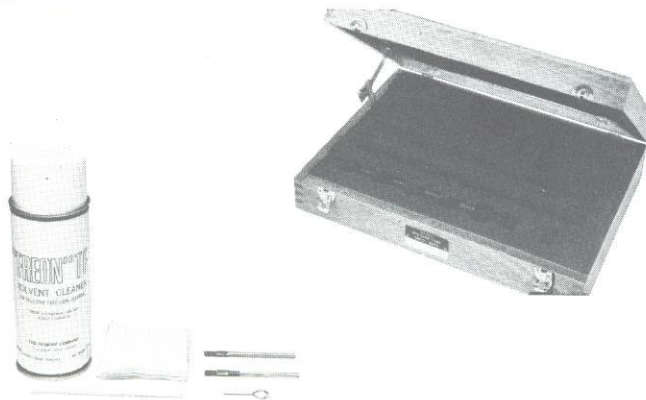

Precision Tube and Rod

Used to fabricate custom-length 14-mm air lines and components in conjunction with GR900 connectors and connector kits. Machining instructions are furnished.

Precision Outer-Conductor Tube

Mechanical: Precision-forged, silver-lined brass; stress relieved to minimize dimensional changes during machining; for use with 890-BT, 900-AB, -AC, -AP, -BT, and -BT (75 Ω) connectors. DIMENSIONS (diameters specified at 23°C): 27 in. (690 mm) long, 0.830 in. nominal OD, 0.5625 in. \pm 220 μ in. ID with straightness of 0.005 in./ft and inner-surface finish of 30 μ in. max, 0.134 in. nominal wall thickness.

50- Ω Precision Inner-Conductor Rod

Electrical: IMPEDANCE: $50 \pm 0.035 \Omega$ ($\pm 0.07\%$) when centered in 0900-9509 tube.

Mechanical: Supplied in pairs; centerless-ground, silver-layered brass rod; for use with 890-BT, 900-AB, -AC, -AP, and -BT connectors. DIMENSIONS (diameters specified at 23°C): 13 ± 0.0312 in. (330 mm) long with straightness of 0.0015 in./ft; 0.24425 in. \pm 65 μ in. dia with uniformity of $\pm 25 \mu$ in. and surface finish of 20 μ in. max.

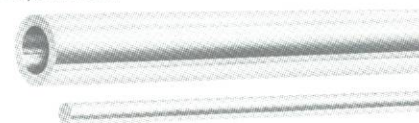

Precision Outer-Conductor Tube
50- Ω Precision Inner-Conductor Rod

0900-9509

0900-9507